

MODELLING OF THE INFLUENCE OF CREEP STRAINS ON THE FIRE RESPONSE OF STEEL ELEMENTS

Torić N.^a, Harapin A.^a, Boko I.^a, Peroš B.^a, Ban M.^a

^a University of Split, Faculty of Civil Engineering, Architecture and Geodesy, Matice Hrvatske 15, HR-21000 Split, Croatia; e-mails: neno.toric@gradst.hr, alen.harapin@gradst.hr, ivica.boko@gradst.hr, bernardin.peros@gradst.hr, maja.ban@gradst.hr

Abstract

The paper presents a numerical model for the behaviour of steel structures exposed to fire capable of taking into account the effect of steel creep at high temperatures by using a simple implicit model. The objective of the simple implicit model is to modify the material stationary stress-strain curves. After reaching temperatures above 400°C, stress-strain curves are modified by stretching the curves using a calculated value of creep strain at current stress, temperature and time. Described numerical procedure was tested by modelling the behaviour of two simply supported steel elements that were partially exposed to high temperatures in an in-house experiment. Authors are claiming that the implicit model is applicable for modelling the behaviour of steel elements with free thermal expansion or with a low level of restriction to thermal expansion.

Keywords: fire, heat transfer, finite element, steel, creep strains

INTRODUCTION

Behaviour of steel structures at high temperatures is greatly influenced by the level of creep strains that occur after reaching the temperature above one third of the melting point of steel. For structural carbon steel, this occurs after reaching the steel temperature of approximately 400°C. Generally, for simply supported steel elements with no axial restraints, the creep strain affects the vertical deflections, while in the elements which are axially restrained, the creep strain induces development of additional forces in the structure (Kodur, Dwaikat 2010). Consequently, creep strains have significant effect on the load bearing capacity of steel structures exposed to fire. Most of the creep models are derived based on material stationary creep tests, in which the steel specimen is heated while the stress is kept constant (Harmathy 1967, Williams-Leir 1983). Implementation of creep strains into the calculation of the structural response is achieved through explicit or implicit creep models. Explicit creep models include creep strains directly into the strain profile of the cross section, where the calculation procedure involves finding the strain profile for which the internal forces are in equilibrium with the applied load forces at one cross section. Afterwards, the moment-curvature relationship for every cross section is calculated, and in dependence on the equilibrated strain profile (curvature), the bending stiffness of the structure member is calculated. Implicit creep models include creep strains directly into the stress-strain curves of the material, thus creating effective relationships in which stress-strain curves are highly nonlinear. However, implicit creep models only partially take into account high temperature creep strain at elevated temperatures, since no calculation of creep strain exists in implicit creep models (Kodur et al 2010). This paper presents a newly developed implicit creep model that calculates creep strains with the help of the existing creep material models in order to modify the stress-strain curves of the material. Consequently, the implicit model creates stress-strain curves that are modified according to the level of stress and temperature that the cross section is exposed to after reaching the critical temperature of steel creep development.

1 NUMERICAL MODEL FOR STRUCTURAL FIRE ANALYSIS

The model is generally based on a spatial beam-column element analysis (spatial frame structures), which has a detailed description in (Torić et al 2012). The model consists of three submodels: a model for structural analysis (Bernoulli beam elements with six degrees of freedom), a model for calculation of the nonlinear stress-strain distribution in the cross-section and a 3D transient nonlinear heat transfer model (eight node cube element). In the calculation procedure the structure is divided into elements and subelements. (Fig. 1, a-b). Each of these elements and subelements has a cross-section consisting of one material or one composite section (Fig. 1-c), and each of the materials of the cross-section has its constitutive material behaviour law (stress-strain curve). Once the model for structural analysis has been formed and the element cross-section defined, the spatial 3D model for heat transfer analysis is automatically formed (Fig. 1-d).

1.1 Structural calculation procedure

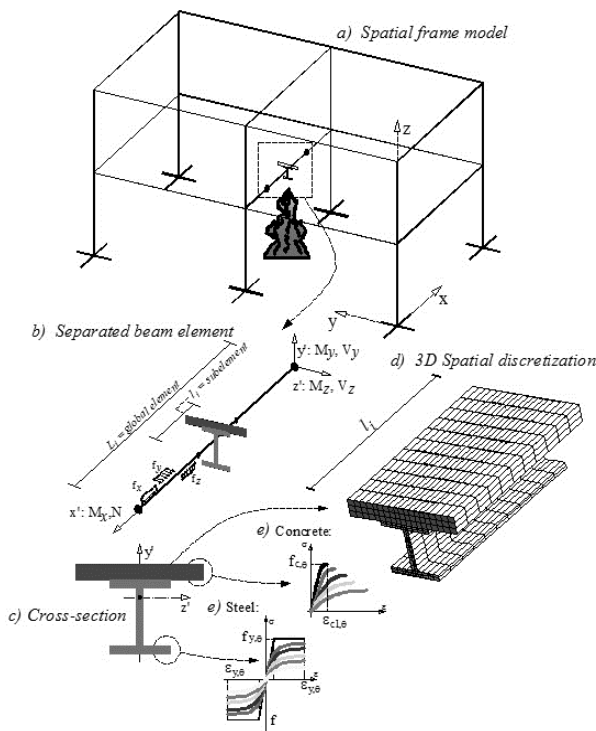

Fig. 1 Presentation of the numerical model

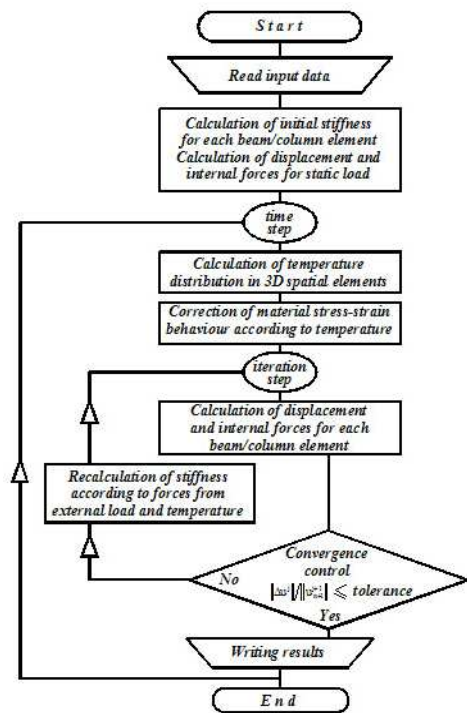

Fig. 2 Structural fire analysis flow-chart

The calculation procedure starts with a linear elastic structural analysis. The structure is loaded with a static load, for which displacements and internal forces are calculated (quasi static analysis). Afterwards, depending on the level of internal forces in each subelement, the structure stiffness matrix is modified according to the nonlinear stress-strain distribution in the cross-section. Strain components in the steel cross-section during fire exposure are comprised of three components (Purkiss 2007):

$$\varepsilon_{tot} = \varepsilon_{th}(T) + \varepsilon_{\sigma}(\sigma, T) + \varepsilon_{cr}(\sigma, T, t) \quad (1)$$

where: ε_{tot} – total strain, $\varepsilon_{th}(T)$ – thermal strain (function of temperature T), $\varepsilon_{\sigma}(\sigma, T)$ – stress related strain (function of both the applied stress σ and the temperature T) and $\varepsilon_{cr}(\sigma, T, t)$ – creep strain (stress, temperature and time dependent strain). Creep strains are excluded from Eq. (1) if an implicit creep model is utilized in the structural analysis. In that case, creep strains are implicitly included in the material stress-strain curves. The implicit model is described in the following chapter. Thermal strains are converted into displacements or internal forces depending on the end restraints of the element. Once the modified stiffness

matrix of the structure is assembled, new structure displacements are calculated until the convergence of the displacement vector is achieved (norm of displacement vector lower than norm limit). This phase can be described as a stationary state of the structure, for the time period before the structural fire analysis starts. Flowchart of the numerical model is presented in Fig. 2.

2 NEW IMPLICIT CREEP MODEL

2.1 Introduction

The idea for a new implicit creep model was developed from the observation of results obtained from classical stationary and transient material tests. For steel, stress-strain curves obtained from transient test differ from those obtained by stationary test, mainly because of the influence of steel creep. Steel creep develops because steel specimens are heated with slow thermal gradient while under stress, which results in a distorted stress-strain curve due to existence of implicitly included creep strain in comparison to stationary curves (Lu et al 2003, Mäkeläinen et al 1998). The main difference is observed in the reduced modulus of elasticity $E_{y,\theta(\text{trans})}$ over the whole stress range, and depending on the temperature level, in a slightly lower yield strength $f_{y,\theta(\text{trans})}$. Fig. 3 presents a typical stress-strain curve obtained by stationary and transient steel testing for a fixed temperature level θ .

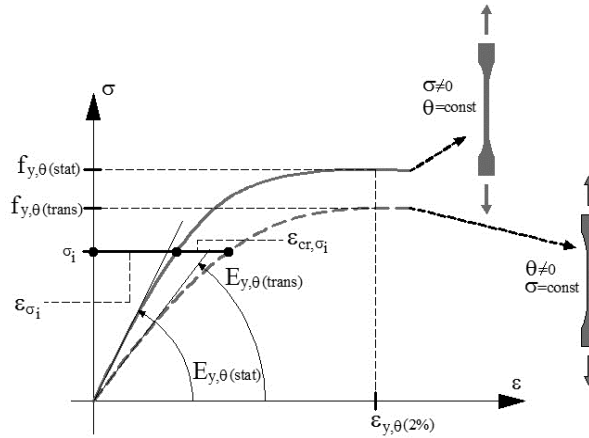

Fig. 3 Comparison of typical stress-strain curves obtained from stationary and transient steel tests

From Fig. 3 it is evident that for each stress level on the curve σ_i , the total deformation on the transient stress-strain curve can be divided into two components: stress related strain ε_{σ_i} and creep strain $\varepsilon_{cr,\sigma_i}$ (thermal deformation excluded). In case of the classical transient test, the level of creep strain that is implicitly included in the stress-strain curve depends upon the level of stress that is kept constant during the test and the imposed heating gradient on the specimen.

2.2 Implementation of the new implicit creep model

The new implicit creep model is based on the observation of dual deformation division of the total sum of deformation observed on the transient stress-strain curve (Fig. 3). The model is based on the calculation of realistic values of creep strains depending on the level of stress and temperature to which the cross section is exposed. Realistic values of creep strain are then used to modify the stationary stress-strain curves. The modification is obtained by adding the calculated creep strain to the value of stress related strain in order to reach values that should correspond in maximum degree to the observed total sum of deformation on transient stress-strain curves from Fig. 3. By adding the calculated creep strain to the stress related strain for each stress level σ_i , the new modified stress-strain curve is obtained which reduces the

modulus of elasticity on the curve and creates a ductile material curve that is similar to stress-strain curve obtained by transient testing of the material.

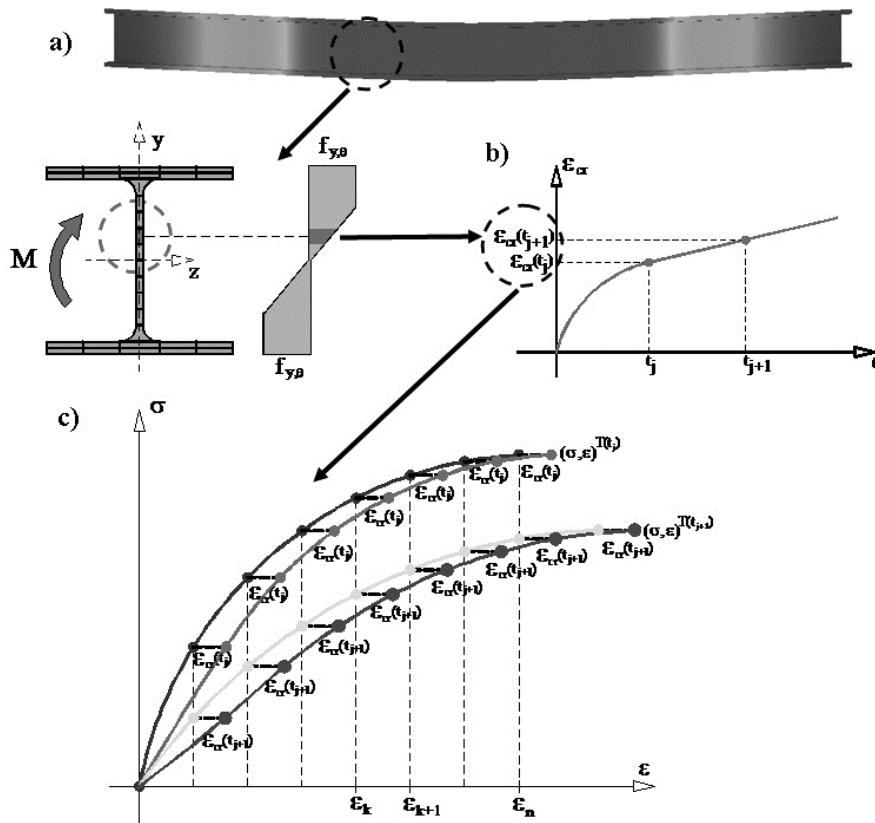

Fig. 4 New implicit creep model for stress-strain curve modification: (a) Temperature calculation; (b) creep strain calculation; (c) strain modified curve

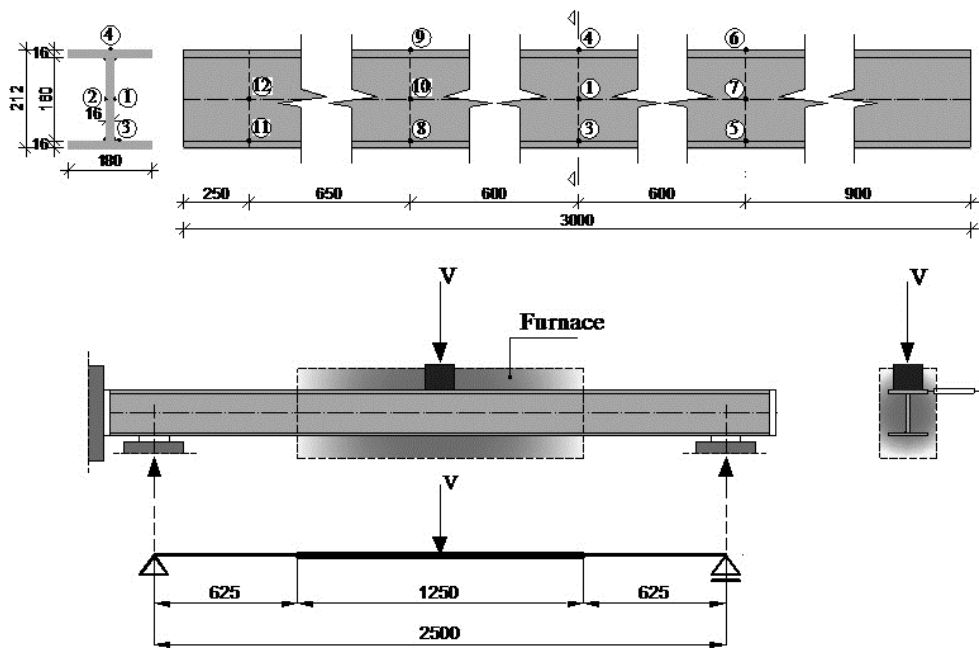

Fig. 5 Temperature measuring points and structure model

Fig. 4 summarizes the proposed implicit calculation procedure. The proposed implicit calculation procedure is modifying stress-strain curves obtained from stationary tests and using them to recreate equivalent transient stress-strain curves. The procedure in this manner creates curves which are influenced by a creep strain that is likely to occur in a certain part of the cross section. The model for calculation of creep strains applied in this study is based on Harmathy’s research (Harmathy 1967). Parameters for calculating creep strains are derived for steel grade A36 (Harmathy et al. 1970), which is equivalent to steel grade S275.

3 NUMERICAL VERIFICATION

Verification of the proposed implicit creep model was conducted on the results of two fire tests (Boko et al 2012). Two simply supported steel beams I 212/180, steel grade S355, with 2.5 m span were previously loaded and then heated on all four sides of the element inside the furnace (Fig. 5). First element (E1) was loaded with concentrated vertical force $V = 200$ kN at midspan and the second element (E2) was loaded with concentrated vertical force $V = 200$ kN and horizontal compressive force $H = 400$ kN. Fig. 5 presents the disposition of discrete temperature measuring points in which temperature development was observed over time, and the structure model used for numerical modelling. Tab. 1 presents basic input parameters for the heat transfer analysis.

Tab. 1 Basic input parameters for heat transfer analysis

Thermal conductivity λ	Specific heat capacity C	Density ρ_a [kg/m ³]	Convection α_c [W/m ² K]	Config. factor Φ	Emissivity ϵ_{res}	Δt [s]
EN1993-1-2	EN1993-1-2	7850.0	50.0	1.0	0.8	0.5

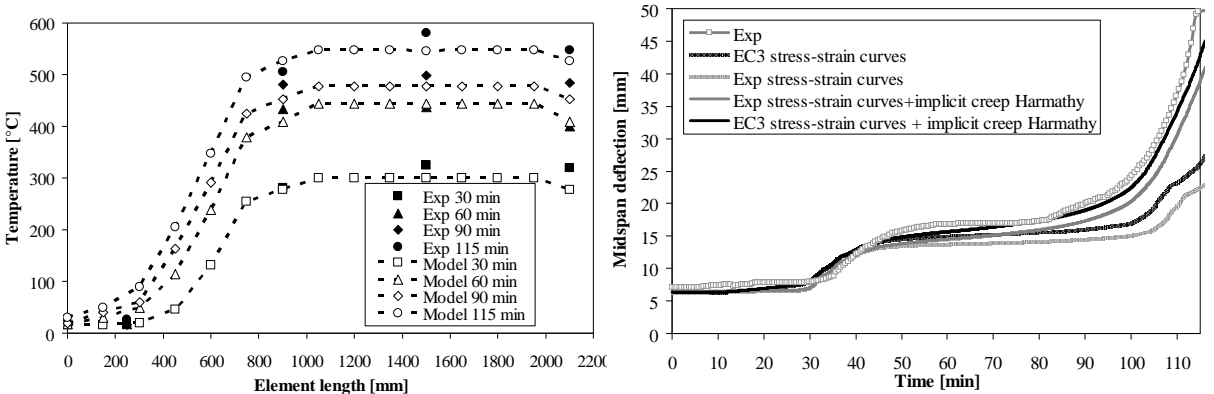

Fig. 6 Comparison of results obtained by model and experiment (Element E1)

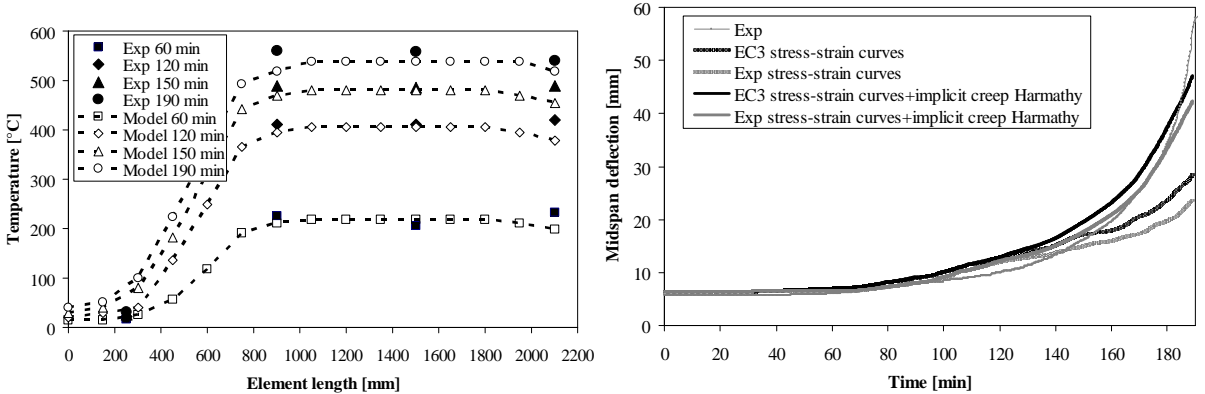

Fig. 7 Comparison of results obtained by model and experiment (Element E2)

The numerical analysis was done by using two different sets of stress-strain curves: experimental stationary stress-strain curves which were determined for steel that was used in the steel beam itself (Boko et al 2012) and the stress-strain curves proposed by EN1993-1-2, generally used for engineering analysis of the behaviour of steel structures under fire. Figs. 6 and 7 present the comparison of results between the conducted experiment and the model predictions.

4 DISCUSSION OF RESULTS

Figs. 6 and 7 show good agreement between the temperatures predicted by the 3D heat transfer model and the measured temperatures during element testing, indicating higher level of precision for temperature predictions if using 3D heat transfer modelling in case of local heating of the element. Both of steel elements were exposed to temperatures above 400°C for at least 70 minutes, thus enabling the development of high temperature creep strains. Figs. 6 and 7 show unconservative results when using both experimental stationary stress-strain curves and steel curves from Eurocode in structural analysis. The unconservative results are obtained without the inclusion of the implicit creep model, for the time period in which steel element is heated above 400°C. The presented implicit creep model is used to modify the initial elasto-plastic steel material model and creates an equivalent visco-plastic material model by modifying stationary stress-strain curves. Results of the deflections obtained by the numerical model show good agreement with the experiment when using the proposed implicit creep model, and therefore, indicate the validity of the applied implicit creep model. However, some discrepancies exist because the applied creep calculation model (Harmathy 1970) is sensitive to input parameters, which are highly variable depending on the type of steel. Creep model was used with the help of experimental parameters derived for steel grade S275. However, steel beams were made of steel grade S355. The present study is focused on the behavior of unrestrained steel elements. Further tests are necessary to confirm the validity of the proposed implicit creep model, especially for the case of restrained steel elements.

REFERENCES

- Boko I., Torić N., Peroš B., *Materialwissenschaft und Werkstofftechnik*, Vol. 43, 2012.
- EN 1993-1-2:2005 Eurocode 3 - Design of steel structures - Part 1-2: General Rules - Structural fire design, European Committee for Standardization, Belgium 2005.
- Harmathy T. Z., *Journal of Basic Engineering*, Vol. 89, p. 496, 1967.
- Harmathy T. Z., Stanzak W. W., *Elevated-Temperature Tensile and Creep Properties of Some Structural and Prestressing Steel*, National Research Council of Canada, Division of Building Research, Canada, 1970.
- Kodur V., Dwaikat M., Fike R., *ASCE Journal of Materials in Civil Engineering*, Vol. 22, p. 423, 2010.
- Kodur V. K. R. , Dwaikat M. M. S., *Materials and Structures*, Vol. 43, p. 1327, 2010.
- Lu W., Mäkeläinen P., *Advanced Steel Structures TTK-TER 29 Report*, Laboratory of Steel Structures, Helsinki University of Technology, 2003.
- Mäkeläinen P., Outinen J., Kesti J., *Journal of Constructional Steel Research*, Vol. 48, p. 47, 1998.
- Purkiss J. A., *Fire Safety Engineering Design of Structures Second edition*, Butterworth-Heinemann, UK, 2007.
- Torić N., Harapin A., Boko I., *Građevinar* Vol. 64, p. 1, 2012.
- Williams-Leir G., *Fire and Materials*, Vol. 7, p. 73, 1983.